



ORCA

NATURAL SURFACES



Know nature - Understand nature.

Various studies confirm the deep-rooted relationship between humans and nature. A closer link with nature assists our wellbeing, whatever age we are. The experience of nature gives relaxation, strength, creativity, continuity and positive feelings. If we have to spend so much time in closed, high-tech rooms, why not include elements of nature in the design? Our surfaces can help bridge this gap.

If a nose catches the scent of our natural surface 'WILDSPITZE', produced from real Alpine Hay, personal well-being in the room improves. The olfactory stimuli are passed on both to the cerebrum, which is responsible for memories, and to the limbic system - our processing centre for emotions of well-being. A personal emotion for the room is created unconsciously.

The scent of fresh hay is deeply impressed in us and reminds us of a life with nature, of holidays on the farm, relaxing holidays in the mountains. After intensive research and experiments, we were finally able to prepare this experience from nature for interiors back in 2012: We processed hay and other pleasantly scented and regional natural materials into decorative surfaces. The original feel and colour, as well as the natural scent, are largely retained. Nature, in its infinite variety of colours and scents, moves into interiors and creates a special experience. Let yourself be inspired!

With Organoid® greetings from Tyrol,

Martin Jehart

Mag. Christoph Egger

Founders and managing directors

PS: We are delighted that we have caught the spirit of the times and about the creativity of our customers! Organoid® natural surfaces can be found in over 4.000 international projects!

CONTENT

1	KNOW NATURE - UNDERSTAND NATURE	21	ORGANOID® LIGHT ON ECO-FLEECE
2 - 3	WHY ORGANOID® NATURAL SURFACES?	22 - 25	ORGANOID® ON HPL
4	THE ROAD TO A NATURAL SURFACE	26 - 27	ORGANOID® ON SELF-ADHESIVE BACKING
5	WE PROTECT WHAT WE LOVE	28 - 29	ORGANOID® ACOUSTICS
6 - 7	WE USE NATURAL RAW MATERIALS...	30 - 31	ORGANOID® FLOORING
8 - 9	...AND PRODUCE NATURAL SURFACES...	32 - 33	ORGANOID® ON FLEXI
10 - 11	...ON DIFFERENT BACKINGS...	34 - 35	INDIVIDUAL PRODUCT DEVELOPMENT
12 - 13	...FOR A WIDE VARIETY OF APPLICATIONS.	36	WE GREEN YOUR COMPANY
14 - 15	INSPIRED BY NATURE	37	CUSTOMER'S STATEMENTS
16 - 19	ORGANOID® ON FLAX BACKING	38 - 39	THE MAIN SUPPLIERS: OUR FARMERS
20	ORGANOID® LIGHT ON FLAX FLEECE	40 - 41	AT HOME WORLDWIDE
			IMPRINT

Why Organoid natural surfaces?

‘The increasing urbanisation and uprooting of humans requires a timely response, with new, natural, spatial concepts: Organoid® natural surfaces.’

Christoph Egger, founder and managing director

Our vision

The present time is increasingly technological and fast-moving and unpredictable. We want people to have a chance to get back to nature and to strengthen this important connection. This happens in natural surroundings, and now it can also happen indoors when our natural surfaces are used with your design.

Natural beauty - naturally as an advantage

The natural beauty of our surfaces comes from nature itself. Nature is the best designer and we only help it to find its way into the living spaces of people with our technical and manual skills.

Our core competence

Buying and processing various untreated natural materials, as locally as possible, to produce climate-positive natural surfaces, on various backing, to suit the required application. There is 100% sustainability, authenticity and a ‘closeness’ to nature in all of our surfaces.

See. Look closely! Do you recognise the natural raw material?



Feel. Can you feel the individual parts of the plant with your fingers?



Smell. Does the scent remind you of something?



Experience & Enjoy. Close your eyes and enjoy the sensory experience.



Tell the story ...about life in harmony with nature.





The road to a natural surface

Production steps of Organoid.

Many small steps are necessary before the Organoid® natural surfaces are ready for sale. Using our 'WILDSPITZE' hay surface as an example, we outline the production steps.

After the strenuous hay cutting at 1 700 to 2 000 m above sea level on the slopes of Wildspitze - Tyrol's highest mountain - we check the quality of the delivery: How does the hay smell? Is it dried well? How coarse are the plant fibres?

Next, the hay is weighed, the long fibres are cut, and then the best is selected.

The ecological binding agent is sieved onto the carrier material together with the fibres in several layers, and processed at high pressure and temperature.

Although it sounds simple, the production is very complex, since, depending on the product and each individual specification, between 40 and 100 parameters have to be considered and adhered to in order to replicate and guarantee consistent quality.

We protect what we love

Organoid® Nature surfaces also store CO₂.

We meet our responsibility for the climate and the environment by being certified as a climate-neutral company. After all, we also use nature's full treasure chest and want to enjoy the variety of colours and scents for a long time to come!

What is not taken into account in the annual calculations of the CO₂ footprint is the amount of CO₂ that the plant fibres we process store within themselves through their biological respiratory processes. One tonne of dried hay stores around 1 500 kg of carbon dioxide. Organoid used around 28 tons of hay for natural surfaces in 2019 and thus bound around 42 000 kg of CO₂. That corresponds to approx. 340 000 km driven in a car!

This CO₂ binding value of the processed fibres is well above the annual calculated CO₂ emissions from the necessary production processes.

Organoid® products can therefore not only be described as climate-neutral, but even as **climate-positive!**





Alpine Hay & Flower Petals

The colourful alpine meadow - delicately fragrant herbs and grasses with the colourful petals of arnica, cornflower, heather, rose and daisy are the basis for the natural surface called ALMWIESN.

Moss

Mosses are among the primeval plants and can be found in humid areas as well as in deserts. They have a germicidal and fungicidal effect and were also used as an antiseptic wound pad and as a biological nappy insert. We use coloured, upcycled moss and thereby extend the life cycle of the valuable plant.



Lavender

Lavender has been known for its calming and harmonising properties for centuries. The intense natural scent is recognised to protect against inner restlessness, difficulty falling asleep and many a nightmare.

Alpine Hay

The delicately scented raw material for our Organoid® natural surface WILDSPITZE grows on the steep mountain slopes of the Tyrolean Oberland from 1 700 m above sea level.

The sunny slopes of the Kaunergrat Nature Park offer the best growing conditions for the species-rich alpine hay with the pleasantly spicy smell...

We use natural raw materials...

The abundance of nature gives us everything we need for our natural surfaces from alpine hay to hop umbels and cornflower blossoms to Swiss stone pine. Any natural raw material can be used. Preferably using organically and regionally produced raw materials that are not processed further in conventional production, we rely on regional partners and short transport routes. To enable individual upcycling storytelling we are also happy to process material from the production or region of our customers. It can be specified by colour (e.g. RAL 4003), by origin (e.g. cocoa bean shells from your own chocolate production) and by mechanical properties (e.g. highly flexible or translucent) or by a medicinal effect (soothing effect of hemp).

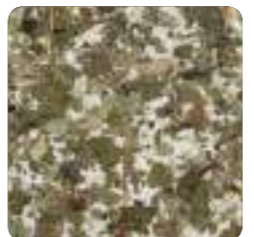

...and produce natural surfaces...

The natural raw materials are mixed with an ecological binding agent and pressed into thin layers in a gentle pressing process - 0.1 to 3 mm thick, depending on the raw material used. The natural surfaces are untreated as standard and are delivered in this original quality as a finished surface. The organoid surfaces are practically emission-free and allergy-tested, ecological and harmless to health, climate regulating and are produced in Tyrol, Austria in a climate-positive manner. Only suitable for indoor use without further sealing. In order to meet particularly high requirements for abrasion, water and scratch resistance and lightfastness, our surfaces can be sealed with conventional oils and varnishes. By the way (to any German speakers): The names of our natural surfaces are not spelling mistakes, but are based on our Tyrolean Oberinntal dialect and strengthen our regional ties.

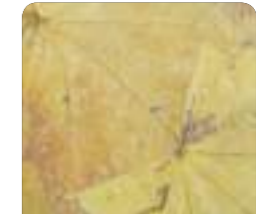

...on different backings...

The thin natural surfaces are pressed by us onto various fleeces, HPL panels, fabrics, papers, self-adhesive films and other materials provided by the customer.

In addition to our stock collection, we produce individual semi-finished products as rolls or sheets up to a width of 1360 mm.

ORGANOID® ON FLAX BACKING

Breathable backing made from 100% flax

Rolled goods available from 1 running metre.
Width: 1360 mm
Total thickness: approx. 1.5 mm
Easy cutting, wall pasting process.

ORGANOID® LIGHT ON FLAX BACKING

Breathable backing made from 100% flax

Rolled goods available from 1 running metre.
Width: 1360 mm
Easy cutting, wall gluing process.

ORGANOID® LIGHT ON ECO-FLEECE

Eco-fleece white made from recycled cellulose and textile fibres

Rolled goods available from 1 running metre.
Width: 1360 mm
Easy cutting, wall gluing process.



ORGANOID® SELF-ADHESIVE

Translucent Self-adhesive film

Rolled goods available from 1 running metre.
Width: 1360 mm
Small bending radii: up to 0.5 mm
Easy assembly: protective paper peel off, stick on and done!

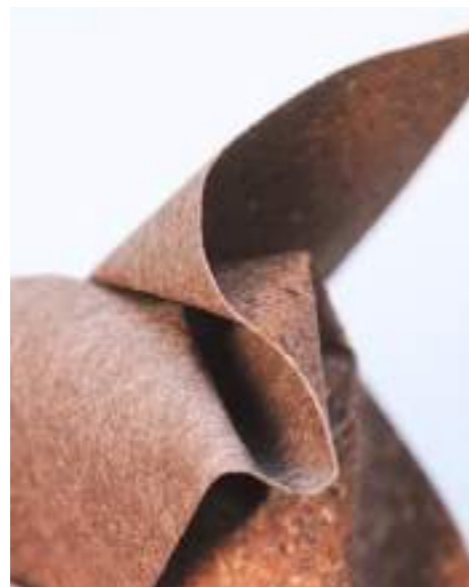

ORGANOID® FLEXI

Thin, flexible fleece without glue penetration

Rolled goods from 1 running metre.
Width: 1360 mm
Processing: like wood veneer
Easy cutting.



ORGANOID® ON HPL

Laminate board (high pressure laminate)

0.8-1.2 mm according to EN 438
Format: 3050 x 1320 mm
Processing like conventional laminate.
Flame retardant in the composite structure.
B-s1, d0 according to EN 13501-1



ORGANOID® ACOUSTICS

Improvement in room acoustics through natural surfaces on panels (on request MDF B-s1, d0, gypsum fiber board A2) or acoustic fleece.

Depending on the requirements, natural fleece, absorber panels, slot and image absorbers with different natural surfaces are available.



ORGANOID® FLOORING

Click system for floating installation or Adhesive flooring - supplied on a cork base for glued-down installation

Classification: Object area 32
Abrasion resistance: AC3
Panel size: 1230 x 305 mm



ORGANOID® CUSTOMISED

We also potentially cover your supplied carrier material, such as textiles, waste wood, paper, etc. directly.

...for a wide variety of applications.

Tried and tested a thousand times over and used worldwide: Exhibition and shop fitting, office space, public buildings, gastronomy, hotel and wellness areas, packaging and design...

SKELETTBLATTLA Flexi white / LeuchtNatur



KORNBLUAMA ROAT special / Hotel haldensee



WILDSPITZE / Bioland Bakery Müller



WILDSPITZE LIGHT Eco-Fleece white

ALMWIESN translucent / Hotel haldensee



WILDSPITZE / VIZONA GmbH, Ansorg GmbH, Visplay GmbH



WILDSPITZE LIGHT Flax



WILDSPITZE / Hotel Oberwirt, Marling

ALMWIESN / Lindner Group KG



WILDSPITZE HIMMELBLAU / Holz Specht GmbH



WILDSPITZE / Hans im Glück Franchise GmbH



ROASNBLIATN special / Hunter Luxury



WILDSPITZE Saunaboard / Jansenberger



Nature inspired.

Organoid® on Flax backing

Natural surfaces on breathable flax fleece with a high density covering



The backing made of 100% flax is breathable and can be processed like heavy wallpaper using regular wallpaper paste. Interior decorators and painters create unique and distinctive walls and ceilings with Organoid® on Flax backing, thereby creating a pleasant room climate! Carpenters appreciate the simple application.

PROCESSING:

Apply with wallpaper paste, simple cutting, minimising waste due to natural scattering optics, bridging cracks.

PRODUCT INFORMATION

- WIDTH: 1360 mm
- LENGTH: can be cut individually - up to 500 running metres
- MINIMUM PURCHASE QUANTITY: 1 running meter (1.36 m²)
- OVERALL THICKNESS: approx. 1.5 mm
- CARRIER: 100 g/m², 100% flax, water jet needled, unbleached
- ADVANTAGES:
The Organoid® on Flax backing is allergy-tested, environmentally friendly and harmless to health, CO₂ neutral, breathable, climate-regulating.



In addition to the Organoid® stock collection, custom-made products can be made with customer-specific raw materials.

WILDSPITZE HIMMELBLAU, WILDSPITZE LIGHT translucent / Restaurant Liebstöckl





ALMWIESN

Masterpiece Melanie Charuso



WILDSPITZE ROSENGARTEN

studioraum GMBH



Lindner Group KG

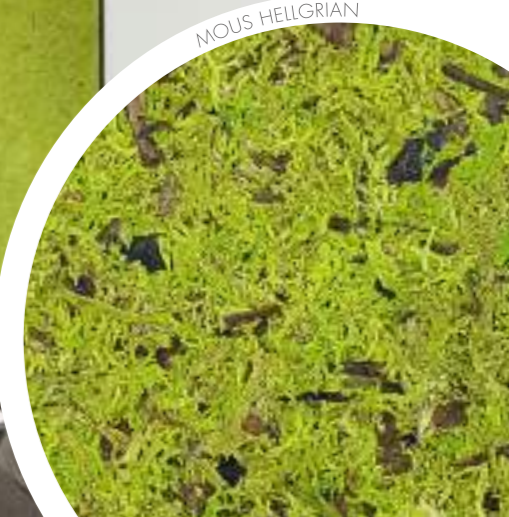

MOUS HELGRAN

Volksbank in Karlsruhe-Durlach

Organoid® Light on Flax backing

Natural surfaces on breathable flax backing with a low density covering

The inexpensive Light products are only coated with a little amount of natural material. The carrier material is thus visible and part of the visual appearance. Whether individual leaves or loosely scattered mixtures of flowers - this offers inspiration and unmistakable surfaces for interior design. The backing made of 100% flax is breathable and can be processed like heavy wallpaper using a standard wallpaper paste. Interior decorators, painters and carpenters create unique and distinctive designs with Organoid®.

Processing:

Apply with wallpaper paste, simple cutting, minimising waste due to natural scattering optics, bridging cracks.

PRODUCT INFORMATION

- WIDTH: 1360 mm
- LENGTH: can be cut individually - up to 500 running metres
- MINIMUM PURCHASE QUANTITY: 1 running metre (1.36 m²)
- OVERALL THICKNESS: approx. 1.0 mm
- CARRIER: 100 g/m², 100% flax, water jet needled, unbleached
- ADVANTAGES:
The Organoid® Light products are allergy-tested, environmentally friendly and harmless to health, CO₂-neutral, breathable, climate-regulating.



We can develop individual and distinctive flax-backed surfaces with you from 200 running metres and a width of up to 1360 mm. We look forward to your enquiry!

Organoid® Light on Eco-Fleece backing

Natural surfaces on Eco-fleece

The inexpensive Light products are only coated with a little amount of natural material. The carrier material is thus visible and part of the visual appearance. Whether individual leaves or loosely scattered mixtures of flowers - this offers inspiration and unmistakable surfaces for interior design. The backing, made from recycled cellulose and textile fibers, is breathable and can be processed like heavy wall cover using a standard wallpaper paste. Interior decorators and painters create unique and distinctive walls and ceilings with Organoid®.

Processing:

Apply with wallpaper paste, simple cutting, minimising waste due to natural scattering optics, bridging cracks.

PRODUCT INFORMATION

- WIDTH: 1360 mm
- LENGTH: can be cut individually - up to 500 running metres
- MINIMUM PURCHASE QUANTITY: 1 running metre (1.36 m²)
- OVERALL THICKNESS: approx. 1.0 mm
- CARRIER: 150 g/m², OEKO-Tex seal, B-s1, d0 according to EN ISO 13501-1
- ADVANTAGES:
The Organoid® Light products are allergy-tested, environmentally friendly and harmless to health, CO₂-neutral, breathable, climate-regulating.



We can develop individual and distinctive products surfaces with you from 200 running metres and a width of up to 1360 mm. We look forward to your enquiry!



Organoid® on HPL

Natural surfaces on laminate boards

This product group is often used for large area wall and ceiling cladding or used as a decorative furniture element. Cabinet makers and joiners, exhibition stand builders and shop fitters can glue and process the Organoid® on HPL products with the existing machinery like ordinary laminates.

Processing:

With regular woodworking machinery as would be the case for any laminates. Use the release paper supplied when pressing.

PRODUCT INFORMATION

- WIDTH: 1 320 mm
 - LENGTH: 3 050 mm
 - MINIMUM PURCHASE QUANTITY: 1 board (4.026 m²)
 - OVERALL THICKNESS: approx. 1 - 4 mm
 - CARRIER: HPL 0.8 mm to 1.1 mm according to EN 438
- Flame retardant according to EN 13501-1.



WILDSPITZE



Sanitätshaus Göldner



ALMWIESN

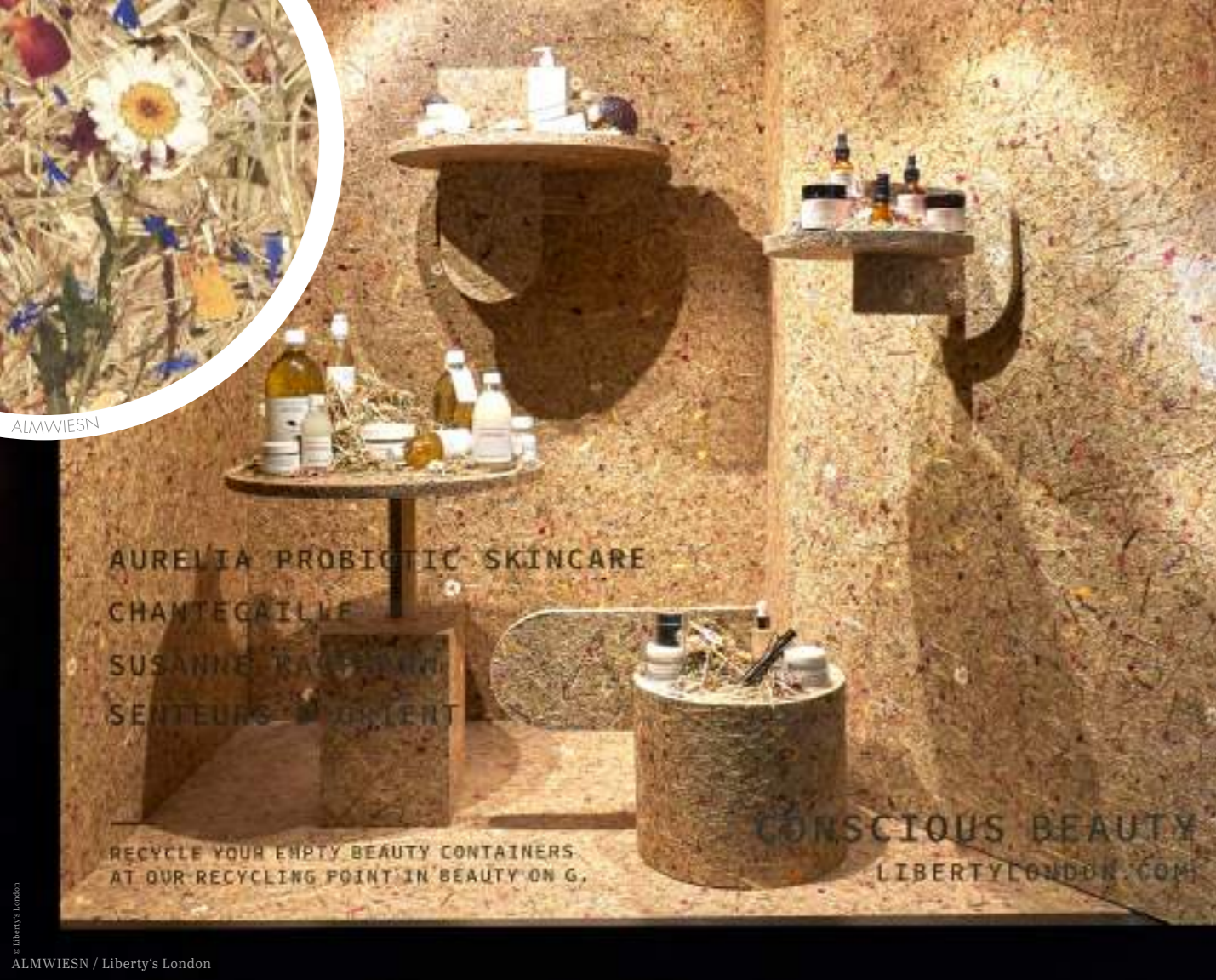

© Liberty's London

ALMWIESN / Liberty's London



© Clutter Brown

Hotel Linde

24
ORGANOID



BAMBOART

Hypo Tirol Bank AG



© S. Cooper/Henrett

Smithsonian Design Museum New York

ROASNBLIATN

Organoid® on Self-Adhesive backing

Natural surfaces on translucent self-adhesive film

Universally applicable for simple gluing on walls or translucent for special lighting effects. The highly adhesive translucent self-adhesive film is suitable for direct bonding on all smooth surfaces such as glass, metal or paper and also for rough surfaces, such as plasterboard and concrete. Also ideal for the subsequent finishing of built-in surfaces. Can also be used as a lampshade or LED light surface, as privacy or glare protection on glass. Special effects are achieved through the individually definable translucency: Depending on the thickness of the Organoid® surface, the surfaces are more or less translucent.

PRODUCT INFORMATION

- WIDTH: 1 360 mm
- LENGTH: can be cut individually - up to 500 running metres
- MINIMUM PURCHASE QUANTITY: 1 running metre (1.36 m²)
- OVERALL THICKNESS: approx. 0.1 - 3 mm
- CARRIER: Translucent self-adhesive film

Processing:

Simply cut to the desired size with scissors, knife or plotter, peel off the protective film on the back and stick it on. Finished! *

* Preliminary tests recommended



Organoid® Acoustics

Natural surfaces combined with effective sound absorption

The Organoid® Acoustic products are coated with natural surfaces in a special production process and processed into fully designed acoustic modules with precisely defined effectiveness.

Depending on the acoustic requirements, the natural top layer, the acoustic processing, module sizes and effectiveness can be customised. Our specialists will be happy to advise you!

PICTURE ABSORBER, acoustic element
wood-based sheet material 16 mm, acoustic perforation, wall distance 0 mm, acoustic dumping 50 mm
Absorber class A α_w 0.90 according to EN ISO 354

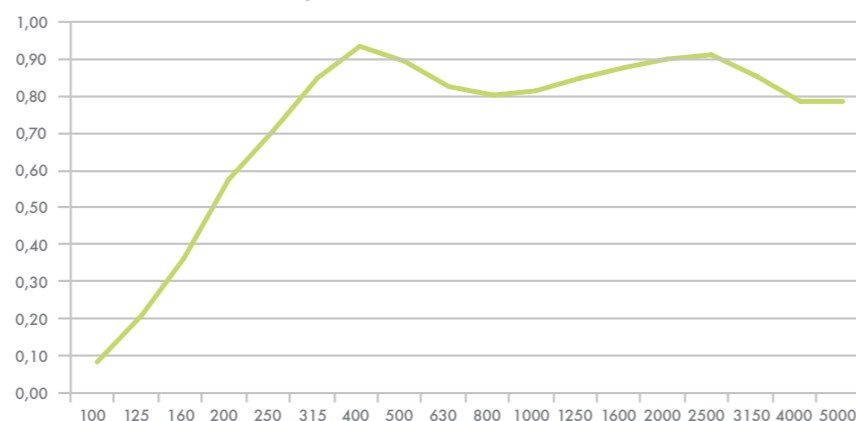

Almost all Organoid®

natural surfaces are suitable as a top layer for the acoustic elements. In addition to the popular hay surfaces, colourful surfaces such as light green moss or blue cornflowers are also used. Organoid® Acoustic products can be suspended from the ceiling, attached to large areas on ceilings

and walls or also act as a decorative element on furniture, doors and walls. The Organoid® Acoustic products can be easily and invisibly fastened using system mounting parts. The acoustic indicators, data and test reports are determined in accordance with EN ISO 354.

**ORGANOID® ACOUSTICS
NON-WOVEN FABRIC**



ORGANOID® ABSORBER PANEL



ORGANOID® PICTURE ABSORBER



Organoid® Flooring

Natural surfaces pressed onto floor panels

Experience the Organoid nature experience with your feet too!



For the natural floor design, PUR-sealed floor panels are available for floating installation or supplied on a cork base for glued floors. The standard design for all floor products is the hay look with the natural surface WILDSPITZE. Other surfaces are possible on request.

The hard-wearing floor covering is suitable for hotel and restaurant floors (object class 32, EN 16511). To meet higher requirements, we recommend the LOBA 2K Duo matt system as a subsequent sealing. Matching skirting boards are available.

PRODUKTINFORMATION

- ORGANOID® CLICK SYSTEM FLOORING:
The practical click system ensures that the floor panels can be laid quickly and easily.
- USABLE SIZE: 305 x 1 230 x 11mm
- MINIMUM ORDER: 1 package (5 panels, approx. 1.88 m²)
- WEIGHT: 8.5 kg/m²
- ORGANOID® ADHESIVE FLOOR:
These cork-backed floor panels with a smooth surface have a total thickness of approx. 5 mm (4 mm cork and 1 mm natural surface).
- USABLE SIZE: 305 x 1 235 x 5mm
- MINIMUM ORDER: 1 package (10 panels, approx. 3.76 m²)
- WEIGHT: 2.7 kg/m²

EASY TO LAY WITH THE CLICK SYSTEM

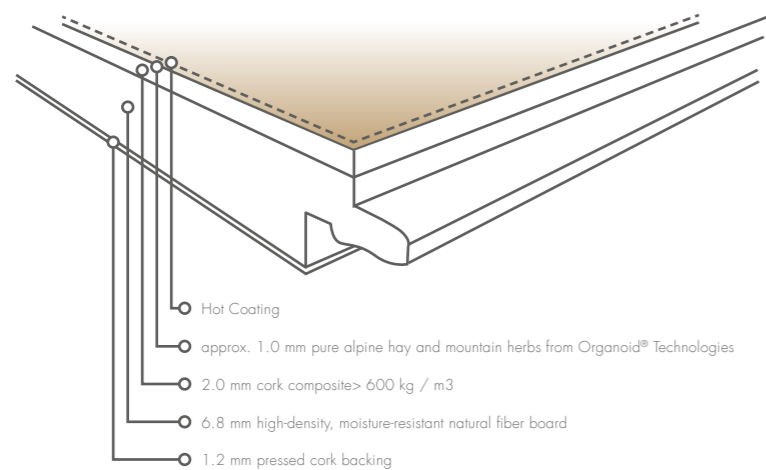

CUSTOMIZE YOUR SURFACE



Organoid® on Flexi

Natural surfaces on a flexible backing

With this product group, it is easy to apply a natural surface to irregular or curved surfaces. Bending radii are possible up to 0.5 mm.

The proven veneer reinforcement fleece - also known as lining paper - serves as a thin and flexible carrier material without glue penetration. After the required cut with scissors or plotter, Organoid® Flexi can be processed like a wood veneer. Wherever thin, flexible carrier material is required, Organoid® Flexi is the right choice! By the way: Organoid® Flexi is also suitable for sewing!

Custom-made products in terms of colour and origin of the raw material, the thickness of the application and the colour of the carrier material are possible. We are happy to help!

PRODUCT INFORMATION

- WIDTH: 1 360 mm
- LENGTH: can be cut individually - up to 500 running metres
- MINIMUM PURCHASE QUANTITY: 1 running metre (1.36 m²)
- OVERALL THICKNESS: approx. 1 - 4 mm
- CARRIER: Veneer reinforcement fleece

Processing:

Simple cutting, gluing like wood veneer.



Individual product development

Special projects require special solutions

Do you need an individually designed natural surface? We have around 500 different natural raw materials permanently in stock and short-term access to a few thousand in order to utilise the potential of millions of years of natural evolution.

We can coat any carrier material. We often produce a sample piece with different variants before we create the recipe with up to 100 parameters in order to ensure consistently high quality in series production.



WILDSPITZE upcycled Swarovski
Circonia special

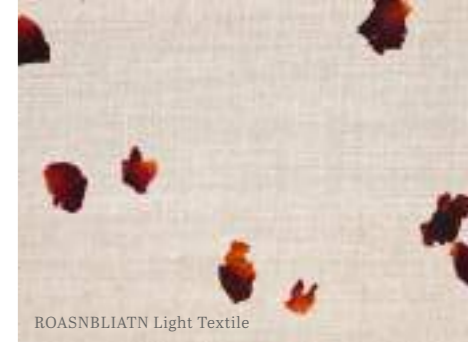

We green your company

By using Organoid® Natural Surfaces, you are making a clear statement to your customers and employees that treating nature with respect is important to you. Adding natural value to your products, with Organoid® natural surfaces, allows you to approach multiple senses of your customers. Don't forget to create YOUR OWN story!



© Christoph Schick

ALMWIESN
/ Bio-Wellnesshotel Holzleiten

' We and our guests particularly like the innovative products from Organoid®, as they bring part of our wonderful nature into the hotel and create an authentic connection between inside and out. The various options for processing products from the Organoid® portfolio also make it exciting and inspiring to work with. It is a pleasure for us every day to experience these elements and to be able to show them to our guests. '

Mag. Simon Wilhelm, owner & managing director of Bio-Wellnesshotel Holzleiten

' The use of Organoid® natural materials helps hotel projects that are geared towards nature, to be more authentic, sustainable and coherent. Their use also enables the enjoyment of the rooms with all of the senses. Organoid® products create identity and contribute to the overall success of a project, making nature a host, both inside and out. '

Hansjörg Franz Krissmer,
Atelier Krissmer & Partner GmbH



SCHILFWEDL / Hotel haldensee



© Lindner Group KG

KORNBLUAMA Blau / Lindner Group KG

' Working worlds - the focus is on people, The Lindner Group KG offers solutions for the implementation of modern and competitive working environments. In the planning process, we find specific answers to questions about acoustics, flexible room design, and sustainable building. Organoid® offers various solutions for these issues. This enables us to offer our customers ideas for flexible surface design, with improved haptics from natural materials. '

Oliver Wieselhuber, Head of the Wall Division, Lindner Group KG



The main suppliers: our farmers.

Thanks to our cooperation with the farmers from the Kaunergrat Nature Park, we can obtain the best alpine hay and flower petals directly from the neighbourhood.

Fifteen farmers from the region are already doing special work and cultivating the steep meadows to get the precious raw material - the delicately scented and species-rich hay.

When is the best time to mow?

The high meadows are mowed only once a year - in August. Then all have grass and flowers together and that ensures growth in the next year. The alpine meadows are not fertilised. Another sign that “the feed is ripe” is when the arnica slowly fades.

Why is it so important to mow the mountain meadows?

In uncut meadows, the tall grasses fall over and simply stay where they are. This prevents the growth of other plants and increases the risk of avalanches in winter, because the snow simply slides off the grass carpet.

The reason why high meadows are often not mowed anymore is, quite simply, that it is not profitable for the farmers, as the time and physical effort is immense.

Why does the hay smell so good?

The pleasantly spicy smell comes from the ingredient coumarin. When the grass dries, the coumarin evaporates and the hay that is now produced is easier for the animals to digest. Sometimes even alpine cows stand by the fence and watch the hay being hauled in, because they would also like a portion of fresh hay.

How difficult is it cutting hay in this environment?

The working conditions in the high meadows have not changed much for centuries. A lot of manual work is still required, as the steepness of the slope means that machines cannot always be used. The whole family usually helps with cutting, clearing, turning and raking. The hay is stored in small barns - called “pill” in our area. It is transported there using tarpaulins that are filled or carried or pulled on the back and head. Harvesting the hay is still real sweaty work here.

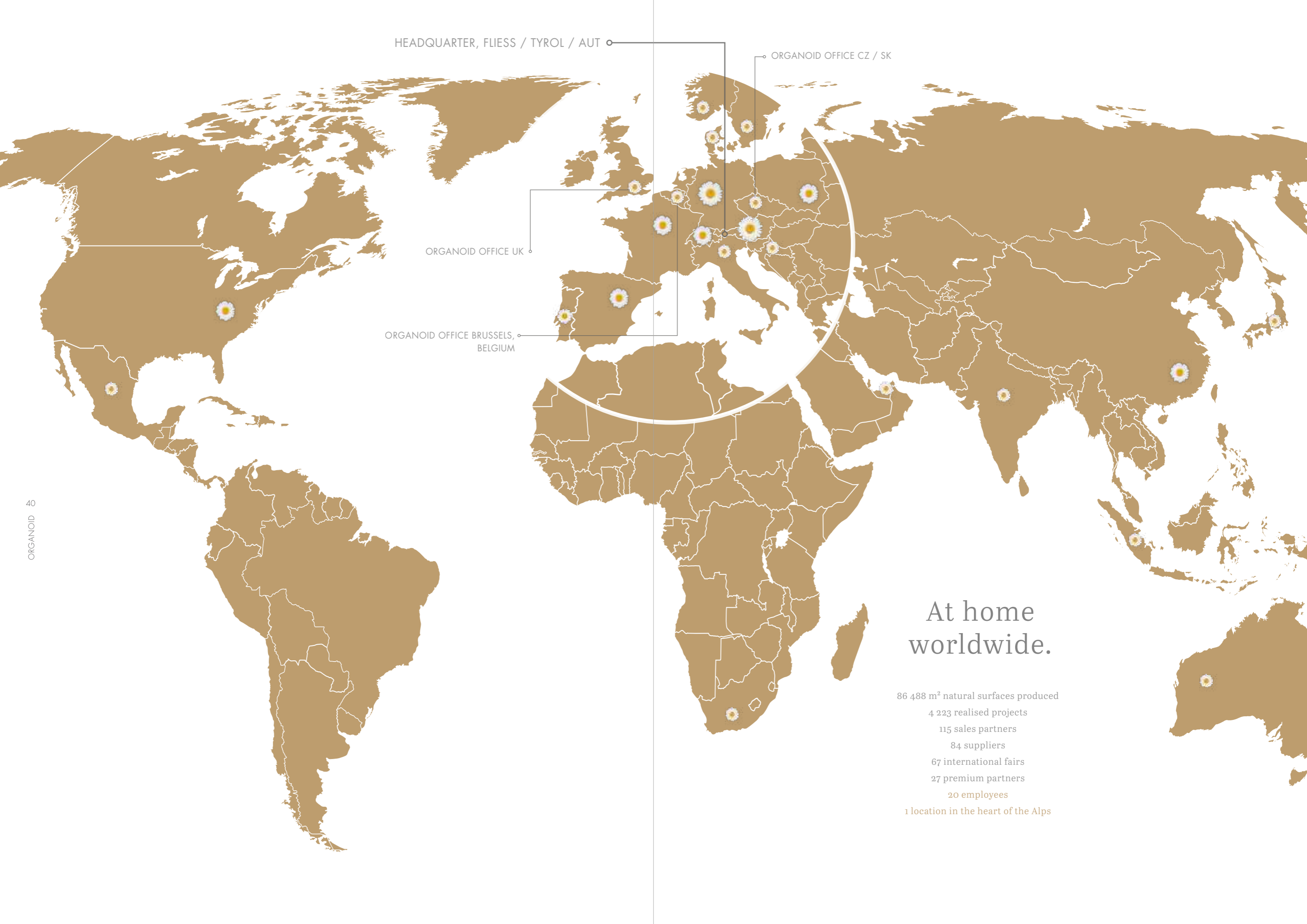

HEADQUARTER, FLIESS / TYROL / AUT

ORGANOID OFFICE CZ / SK

ORGANOID OFFICE UK

ORGANOID OFFICE BRUSSELS,
BELGIUM

At home worldwide.

86 488 m² natural surfaces produced

4 223 realised projects

115 sales partners

84 suppliers

67 international fairs

27 premium partners

20 employees

1 location in the heart of the Alps



Organoid Technologies GmbH
Nesselgarten 422 / 6500 Fliess / Austria
info@organoids.at / tel +43 5449 200 01

www.organoids.com

